

## SPICE thermal model

BUK9Y25-80E

Symbol	Parameter	Conditions	Min	Typ	Max	Unit
$R_{th(j-mb)}$	thermal resistance from junction to mounting base		-	-	1.58	K/W

$C_{th1}$	2.916E-05 F
$C_{th2}$	1.726E-04 F
$C_{th3}$	2.092E-04 F
$C_{th4}$	1.786E-03 F
$C_{th5}$	2.130E-03 F
$C_{th6}$	8.451E-03 F
$C_{th7}$	8.634E-02 F
$R_{th1}$	2.749E-03 $\Omega$
$R_{th2}$	5.716E-03 $\Omega$
$R_{th3}$	4.154E-02 $\Omega$
$R_{th4}$	5.616E-02 $\Omega$
$R_{th5}$	3.287E-01 $\Omega$
$R_{th6}$	1.016E+00 $\Omega$
$R_{th7}$	1.301E-01 $\Omega$

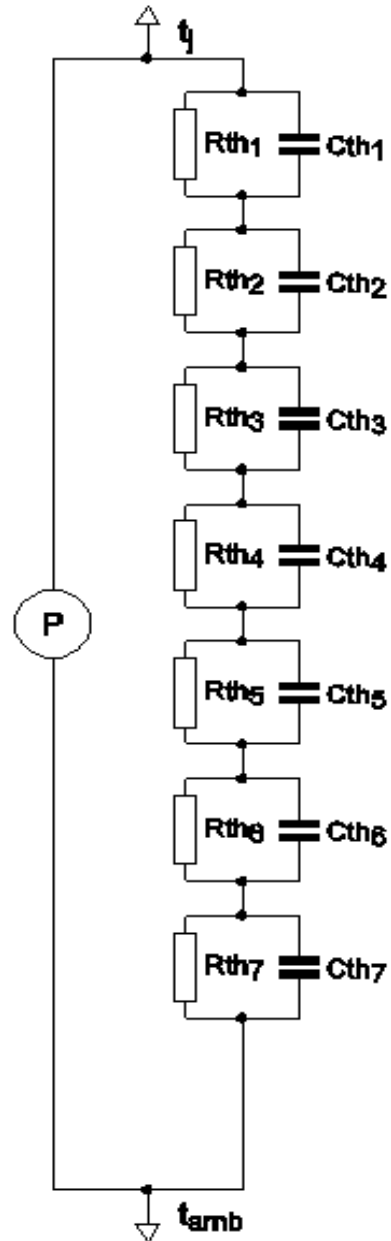

Part: BUK9Y25-80E  
 Date: 25/1/2013  
 Rth 1.58 K/W